

VARIMETER IMD Insulation Monitor MK 5880N, MH 5880

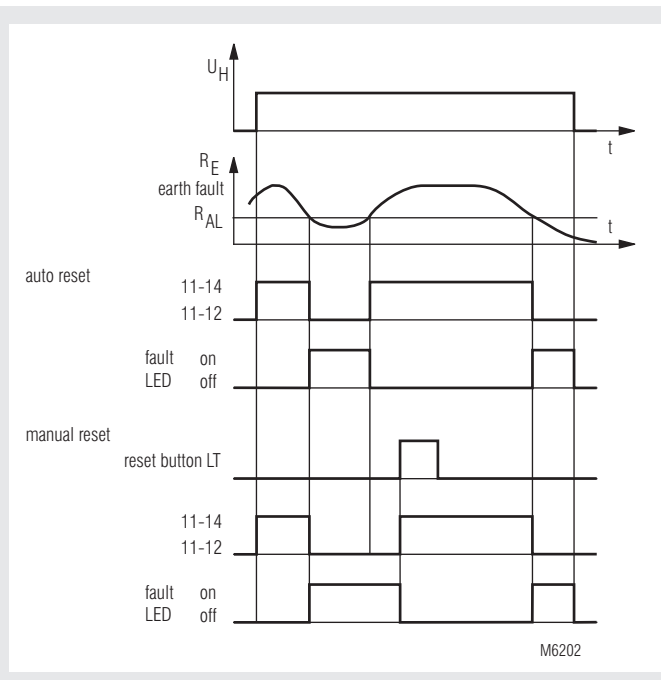

- According to IEC/EN 61 557-8
- For single and 3-phase AC-systems up to 0 ... 500 V and 10 ... 1000 Hz
- Monitors also disconnected voltage systems
- Adjustable tripping value R_{AL} of 5 ... 100 k Ω
- De-energized on trip
- Auxiliary voltage, measuring circuit and output contacts are galvanically separated
- Manual and auto reset
- With test and reset button
- Connections for external test and reset buttons possible
- LED indicators for operation and alarm
- 2 changeover contacts
- MK 5880N/200 with additional prewarning
 - adjustable prewarning value 10 k Ω ... 5 M Ω
 - 1 output relay for alarm and 1 for pre-warning
- MH 5880/500: similar to MK 5880N but with galvanic separated analogue output and 11 step LED chain for the actual insulation value
- Wire connection: also 2 x 1.5 mm² stranded ferruled, or 2 x 2.5 mm² solid DIN 46 228-1/-2/-3/-4
- As option with pluggable terminal blocks for easy exchange of devices
 - with screw terminals
 - or with cage clamp terminals
- MK 5880N: 22.5 mm width
MH 5880: 45 mm width

Function diagram



MK 5880N

Approvals and Markings



¹⁾ only MK 5880N, see CCC-Data

Applications

- Monitoring of insulation resistance of ungrounded voltage systems to earth
- MK 5880N/200 can also be used to monitor standby devices for earth fault, e. g. motor windings of devices that have to function in the case of emergency.
- Other resistance monitoring applications

Notes

When monitoring 3-phase IT systems it is sufficient to connect the insulation monitor only to one phase. The 3-phases have a low resistive connection (approx. 3 - 5 Ω) via the feeding transformer. So failures that occur in the non-connected phases will also be detected.

Function

The device is connected to the supply via terminals A1-A2. The unit can either be supplied from the monitored voltage system or from a separate auxiliary supply. Terminal L is connected to the monitored voltage and PE to earth. If the insulation resistance R_E drops below the adjusted alarm value R_{AL} the red LED goes on and the output relay switches off (de-energized on trip). If the unit is on auto reset (bridge between LT1-LT2) and the insulation resistance gets better (R_E rises), the insulation monitor switches on again with a certain hysteresis and the red LED goes off. Without the bridge between LT1-LT2 the Insulation monitor remains in faulty state even if the insulation resistance is back to normal. The reset is done by pressing the internal or external reset button or by disconnecting the auxiliary supply. By activating the "Test" button an insulation failure can be simulated to test the function of the unit.

The variant MK 5880N.38/200 has a second setting range with a higher resistance up to 5 M Ω (Potentiometer R_{VV}). This setting value can be used for pre-warning with relay output.

When set to manual reset the latching is active on both settings R_{AL} and R_{VV} . Therefore it is possible in the case of a short insulation decrease that the fault is stored and passed via contacts 21-22-24 to a PLC while the main fault does not lead to a disconnection of the mains via the contacts 11-12-14.

Function diagramm

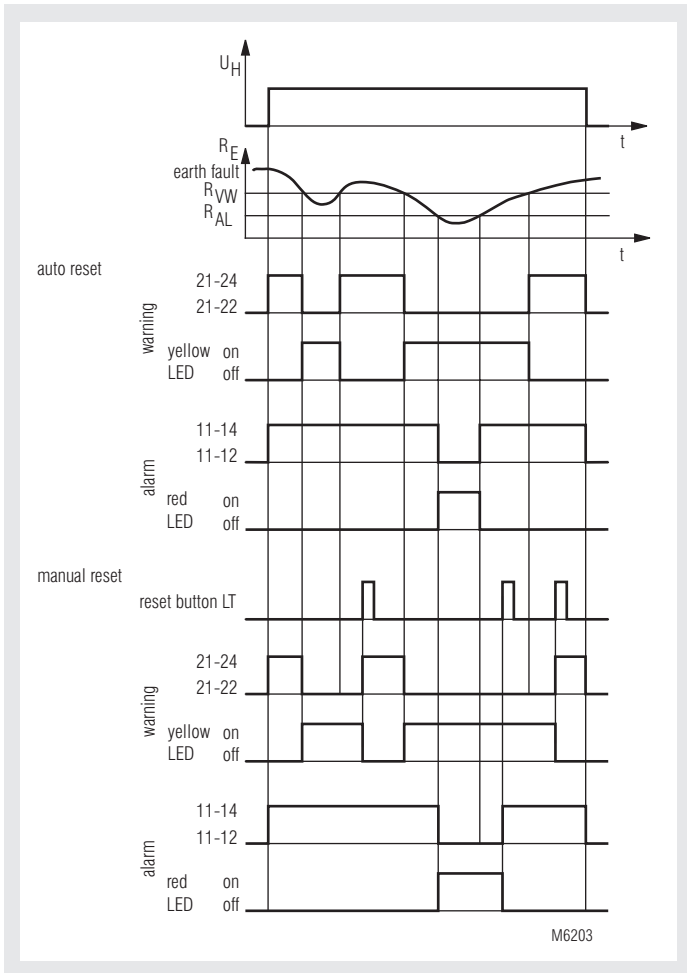

M6203

MK 5880N/200

Circuit diagram

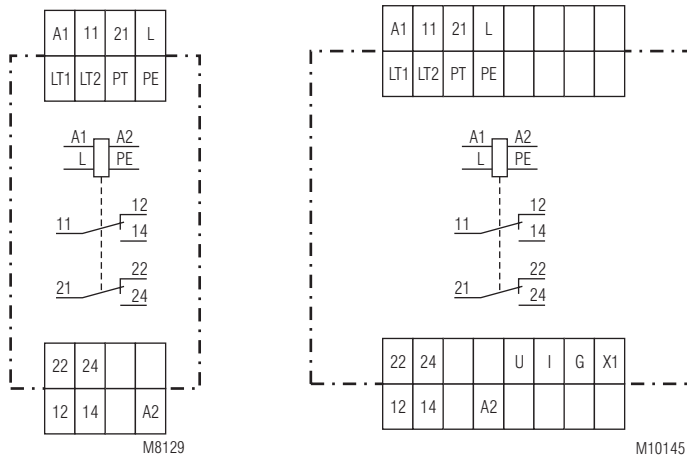

MK 5880N

MH 5880

Connection Terminals

Terminal designation	Signal designation
A1, A2	Auxiliary voltage
L	Connection for measuring circuit
PE	Connection for protective conductor
PT/(PE)	Connection for external test button
LT1/LT2	Connection for external reset or control input for hysteresis function or manual reset LT1/LT2 bridged: Hysteresis function LT1/LT2 not bridged: Manual reset
11, 12, 14	Alarm signal relay (1 changeover contact)
21, 22, 24 ¹⁾	Prewarning signal relay (1 changeover contact)
U, I, G, X1 ²⁾	Analogue output X1/G not bridged: U-G 0 ... 10V; I-G 0 ... 20mA X1/G bridged: U-G 2 ... 10V; I-G 4 ... 20mA

¹⁾ only MK 5880N/200 and MH 5880
²⁾ only MH 5880

Indicators

green LED "ON":	On, when supply voltage connected
red LED "AL":	On, when insulation fault detected ($R_E < R_{AL}$)
yellow LED "VW":	On, when insulation resistance is under prewarning value, $R_E < R_{vw}$ (only with variant MK 5880N.38/200)

Notes

The insulation monitor MK 5880N is designed to monitor AC-voltage systems. Overlaid DC voltage does not damage the instrument but may change the conditions in the measuring circuit. In one voltage system only one Insulation monitor must be connected. This has to be observed when coupling voltage system.

Line capacitance C_E to ground does not influence the insulation measurement, as the measurement is made with DC-voltage. It is possible that the reaction time in the case of insulation fault gets longer corresponding to the time constant $R_E * C_E$. The model MK 5880N.38/200 can be used, because of its higher setting value up to 5 MΩ, to monitor single or 3-phase loads for ground fault. If the load is operated from a grounded system the insulation resistance of the load can only be monitored when disconnected from the mains. This is normally the fact with loads which are operated seldom or only in the case of emergency but then must be function (see connection example).

The auxiliary supply can be connected to a separate auxiliary supply or to the monitored voltage system. The range of the auxiliary supply input has to be observed.

The MH5880/500 has in addition to the prewarning function also a galvanic separated analogue output and an 11 step LED chain indicator, that displays the actual insulation value between 20 kΩ and 1 MΩ. On terminals U/G of the analogue output 0-10 V are provided, on terminals I/G 0-20 mA are available. By bridging terminals X1 and G the output can be switched over to 2-10 V and 4-20 mA. For the scaling of the analogue output see diagram M10142.

Setting

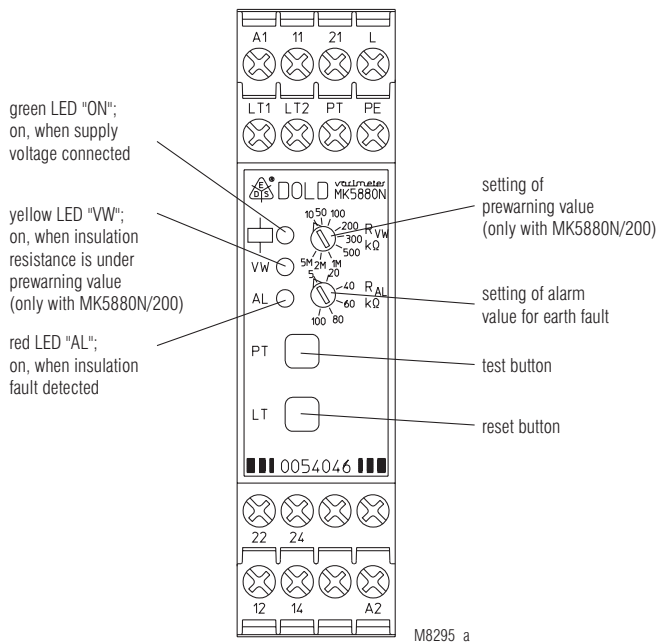

Technical Data

Output

Contacts:

MK 5880N.12:	2 changeover contacts
MK 5880N.38/200:	2 x 1 changeover contact
Thermal current I_{th}:	4 A

Switching capacity

to AC 15	3 A / AC 230 V	IEC/EN 60 947-5-1
NO contact:	1 A / AC 230 V	IEC/EN 60 947-5-1
NC contact:	1 A / DC 24 V	IEC/EN 60 947-5-1
to DC 13:		IEC/EN 60 947-5-1

Electrical life

to AC 15 at 1 A, AC 230 V: $\geq 3 \times 10^5$ switching cycles

Short circuit strength

max. fuse rating: 4 A gL IEC/EN 60 947-5-1

Mechanical life:

$\geq 30 \times 10^6$ switching cycles

Analogue output with MH 5880/500

galvanic separation AC 3750V

to auxiliary supply, measuring circuit and relay output

terminal U(+) / G(-):	0 ... 10 V, max. 10 mA
terminal I (+) / G(-):	0 ... 20 mA, burden 500 Ohm
change to 2 ... 10 V or 4 ... 20 mA by bridging terminal X1 and G (see diagram M10142)	

General Data

Operating mode:

Continuous operation

Temperature range:

- 20 ... + 60°C

Clearance and creepage distances

rated impulse voltage / pollution degree		IEC 60 664-1
between auxiliary supply connections (A1- A2):	4 kV / 2 at AC-auxiliary voltage	IEC 60 664-1
between measuring input connections (L - PE):	4 kV / 2	IEC 60 664-1
between auxiliary supply and measuring input connections:	4 kV / 2 (3 kV at DC-auxiliary voltage)	IEC 60 664-1

EMC

Electrostatic discharge:	8 kV (air)	IEC/EN 61 000-4-2
Fast Transients:	2 kV	IEC/EN 61 000-4-4
Surge voltages		
between A1 - A2:	1 kV	IEC/EN 61 000-4-5 (at AC-auxiliary voltage)
between L - PE:	1 kV	IEC/EN 61 000-4-5
Interference suppression:	Limit value class B	EN 55 011

Degree of protection

Housing:	IP 40	IEC/EN 60 529
Terminals:	IP 20	IEC/EN 60 529

Housing:

Thermoplastic with V0 behaviour according to UL subject 94
Amplitude 0.35 mm
frequency 10 ... 55 Hz IEC/EN 60 068-2-6
20 / 060 / 04 IEC/EN 60 068-1

Climate resistance:

EN 50 005

Terminal designation:

DIN 46 228-1/-2/-3/-4

Wire connection

Screw terminals (integrated):
1 x 4 mm² solid or
1 x 2.5 mm² stranded ferruled or
2 x 1.5 mm² stranded ferruled or
2 x 2.5 mm² solid

Insulation of wires

or sleeve length: 8 mm

Plug in with screw terminals

max. cross section

for connection: 1 x 2.5 mm² solid or
1 x 2.5 mm² stranded ferruled

Insulation of wires

or sleeve length: 8 mm

Technical Data

Auxiliary circuit

Nominal voltage U_N : AC 220 ... 240 V, AC 380 ... 415 V
DC 12 V, DC 24 V

Voltage range

AC: 0.8 ... 1.1 U_N
DC: 0.9 ... 1.25 U_N
Frequency range (AC): 45 ... 400 Hz

Nominal consumption:

AC: approx. 2 VA
DC: approx. 1 W

Measuring circuit

Nominal voltage U_N : AC 0 ... 500 V
Voltage range: 0 ... 1.1 U_N
Frequency range: 10 ... 1000 Hz
Alarm value R_{AL} : 5 ... 100 k Ω
Prewarning value R_{VW} (only at MK 5880N/200): 10 k Ω ... 5 M Ω
Setting R_{AL} , R_{VW} : infinite variable
Internal test resistor: equivalent to earth resistance of < 5 k Ω
Internal AC resistance: > 250 k Ω
Internal DC resistance: > 250 k Ω
Measuring voltage: approx. DC 15 V, (internally generated)
Max. measuring current ($R_E = 0$): < 0.1 mA
Max. permissible noise DC voltage: DC 500 V
Operate delay
at $R_{AL} = 50$ k Ω , $C_E = 1$ μ F
 R_E from ∞ to 0.9 R_{AL} : approx. 1.3 s
 R_E from ∞ to 0 k Ω : approx. 0.7 s
Hysteresis
at $R_{AL} = 50$ k Ω : approx. 15 %

Technical Data

Plug in with cage clamp terminals

max. cross section for connection: 1 x 4 mm² solid or 1 x 2.5 mm² stranded ferruled

min. cross section for connection: 0.5 mm²

Insulation of wires or sleeve length: 12 ±0.5 mm

Wire fixing: Plus-minus terminal screws M 3.5 box terminals with wire protection or cage clamp terminals
DIN rail IEC/EN 60 715

Mounting:

Weight
MK 5880N: approx. 180 g
MH 5880: approx. 320 g

Dimensions

Width x height x depth

MK 5880N: 22.5 x 90 x 97 mm
MK 5880N PC: 22.5 x 111 x 97 mm
MK 5880N PS: 22.5 x 104 x 97 mm
MH 5880: 45 x 90 x 97 mm

CCC-Data

Auxiliary circuit

Nominal voltage U_N : AC 220 ... 240 V
DC 12 V, DC 24 V

Switching capacity:

to AC 15
NO contact: 1.5 A / AC 230 V



Technical data that is not stated in the CCC-Data, can be found in the technical data section.

Standard type

MK 5880N.12 AC 220 ... 240 V

Article number: 0054044
• Auxiliary voltage U_H : AC 220 ... 240 V
• adjustable
alarm value R_{AL} : 5 ... 100 k Ω
• Width: 22.5 mm

Variants

MK 5880N.38/200: with pre-warning
MH 5880.38/500: similar to MK 5880N but with galvanic separated analogue output (current/voltage) and 11 step LED chain for the actual insulation value
Width: 45 mm

Ordering example for variants

MK 5880N .38 PS /200 AC 380 ... 415 V AL 5 ... 100 k Ω VW 10 K ... 5M Ω

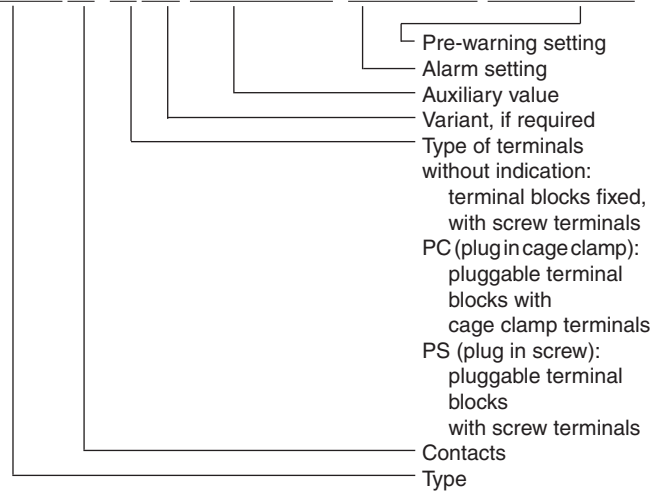

Options with Pluggable Terminal Blocks

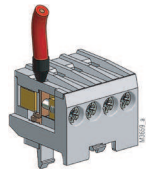

Screw terminal (PS/plugin screw)

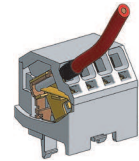

Cage clamp terminal (PC/plugin cage clamp)

Notes

Removing the terminal blocks with cage clamp terminals

1. The unit has to be disconnected.
2. Insert a screwdriver in the side recess of the front plate.
3. Turn the screwdriver to the right and left.
4. Please note that the terminal blocks have to be mounted on the belonging plug in terminations.

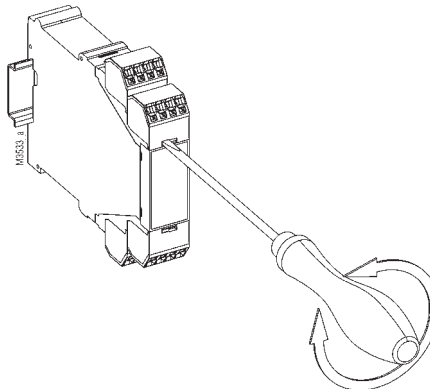

MH5880

Analogue Output Voltage U_A
against Insulation Resistance R_E

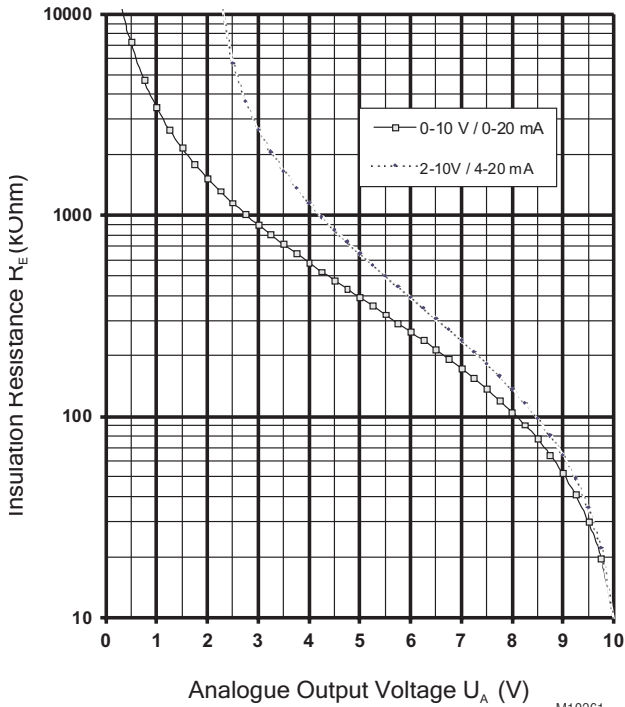

M10261

Analogue output voltage is proportional to the insulation resistance R_E

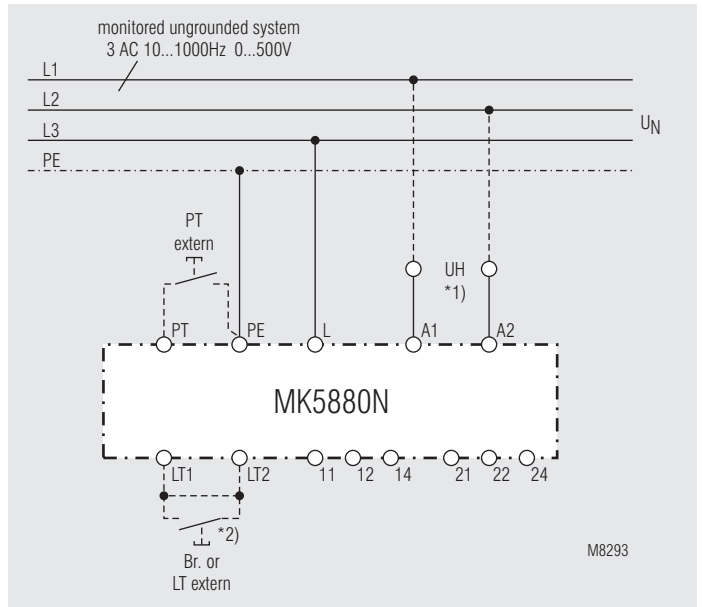

Monitoring of an ungrounded voltage system.

- *1) Auxiliary supply U_H (A1 - A2) can be taken from the monitored voltage system. The range of the auxiliary supply input must be observed.
- *2) with bridge LT1 - LT2: automatic reset
without bridge LT1 - LT2: manual reset, reset with button LT

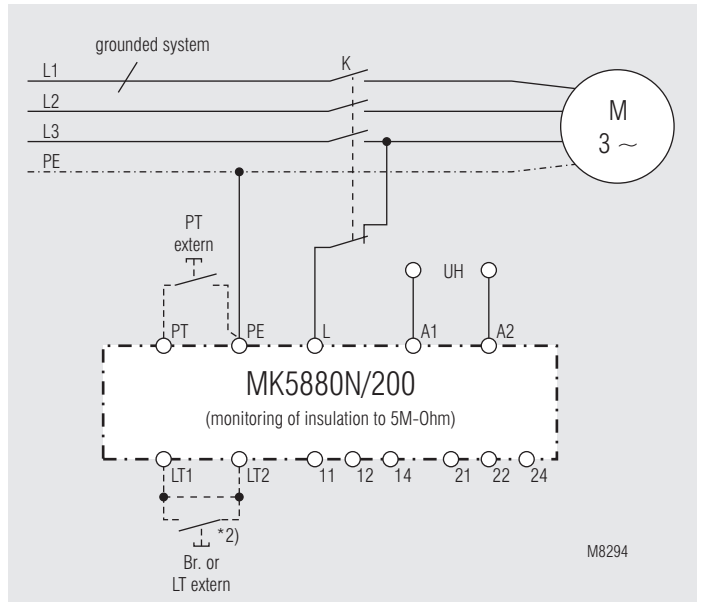

Monitoring of motorwindings against ground

The insulation of the motor to ground is monitored as long as contactor K does not activate the load.

- *2) with bridge LT1 - LT2: automatic reset
without bridge LT1 - LT2: manual reset, reset with button LT

